



AWT07MLEDT HD Monitor

USER MANUAL

ISSUED OCTOBER 2018

! WARNING

Failure to follow all instructions and safety precautions in this manual, in the vehicle and body manufacturers' manuals and on the safety decals attached to the vehicle, body and this product could result in serious injury or death to operators, service technicians or bystanders and/or damage to property.

DO NOT operate the vehicle or install this product before you READ and UNDERSTAND the vehicle Operation Manual, this manual and other applicable manufacturers' manuals, and all safety decals. This product must be installed by certified technicians/installers familiar with the vehicles on which they will be making the installation.



TABLE OF CONTENTS

Monitor

AWT07MLEDT	3
Features	4
Package Contents	5
TFT Installation	6
Signal Cable Description	7
Control Cable Description	9
Front Panel Control	12
OSD Menu	12
Screen Menu	12
Display	12
Camera	12
Information	12
Vehicle Installation	27
Specifications	29
Mounting	31
Cable Connections	33
Index	34

SAFETY PRECAUTIONS

Federal Communications Commission (FCC) Statement

This Equipment has been tested and found to comply with the limits for a Class B digital device, pursuant to Part 15 of the FCC rules. These limits are designed to provide reasonable protection against harmful interference in a residential installation. This equipment generates, uses and can radiate radio frequency energy and, if not installed and used in accordance with the instructions, may cause harmful interference to radio communications. However, there is no guarantee that interference will not occur in a particular installation. If this equipment does cause harmful interference to radio or television reception, which can be determined by turning the equipment off and on, the user is encouraged to try to correct the interference by one or more of the following measures:

- Reorient or relocate the receiving antenna.
- Increase the separation between the equipment and receiver.
- Connect the equipment into an outlet on a circuit different from that to which the receiver is connected.
- Consult the dealer or an experienced radio / TV technician for help.

You are cautioned that changes or modifications not expressly approved by the party responsible for compliance could void your authority to operate the equipment.

NOTICE

This device complies with Part 15 of the FCC Rules. Operation is subject to the following two conditions:

1. This device may not cause harmful interference and,
 2. This device must accept any interference received, including interference that may cause undesired operation
-

PRODUCT DOCUMENTATION UPDATES

Thank you for purchasing our product. Please read this User Manual before using the product. All product documentation is subject to change without notice. Please go to www.3rdeyecam.com to get the most current documentation for your 3rd Eye products.



3RD EYE®

USER MANUAL
AWT07MLEDT

AWT07MLEDT HD MONITOR
7" Q TFT LCD MONITOR (LED BACKLIGHTED)

USER MANUAL
ISSUED OCTOBER 2018
3E-AWT07MLEDT-UM-1018

USER MANUAL

AWT07MLEDT

FEATURES

This heavy duty 4 port monitor is designed to withstand shock and vibrations of up to 10G, repel water intrusion, salt and handle extreme temperatures.

Split, Tri and Quad screen viewing is available on this 7" screen. The AWT07MLEDT is a rugged, robust monitor protected by die cast aluminum housing with the highest military specs suitable for the toughest known environments.

1. Advanced OSD Menu for easy use
2. Supports up to 4 CCD Camera inputs (Mini DIN connector)
3. Extra RCA input for multimedia while parking (VCD, DVD, Game device)
4. Provide 2 Video / 1 Audio Signal Output (Live Out)
5. Support Single / Dual / Triple / Quad Screen (Cam Out)
6. Signal Trigger for Side / Rear View
7. Auto Day & Night Control via Photo Diode Sensor
8. Auto Detection for NTSC / PAL System
9. OSD Control for Individual Normal / Mirror Camera Image for every camera
10. Auto power on when users are making left turn or right turn even reverse
11. Able to select CAM A / B/C / R's monitoring screen
12. Supported 9.6V~32V Car power system working
13. Professional Metal Case with Anti Shocking Design

USER MANUAL

AWT07MLEDT

PACKAGE CONTENTS

ITEM	QTY
1. 7" LCD Monitor	1
2. Sun-Hood	1
3. Mounting Bracket	1
4. Accessories	1
5. Control Cable	1
6. User Manual	1

USER MANUAL

AWT07MLEDT

TFT INSTALLATION

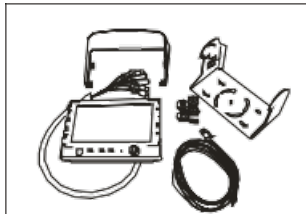

STEP 1

Check the package and make sure all parts are included.

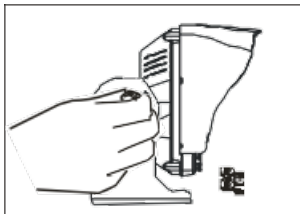

STEP 5

Adjust the monitor to an appropriate / comfortable viewing angle before tightening the screws.

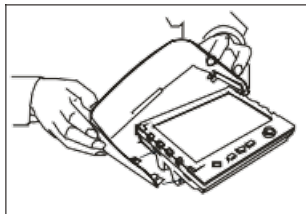

STEP 2

Clip the sun-hood on to the monitor.

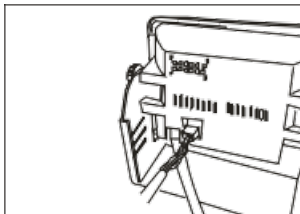

STEP 6

Connect the control cable included to the power socket which located at rear side of monitor.

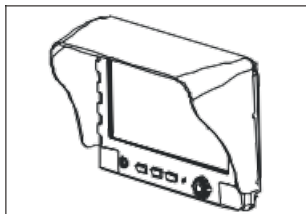

STEP 3

Make sure it is installed properly.

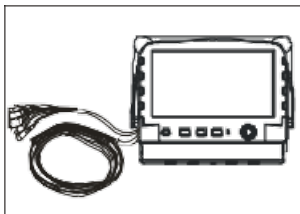

STEP 7

Monitor installation is now completed. Each control cable wire is attached with a sticker to indicate its signal function. Referred to the identification sticker for further installation.

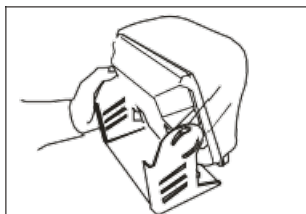

STEP 4

Install the monitor on to the bracket.

USER MANUAL

AWT07MLEDT

SIGNAL CABLE DESCRIPTION

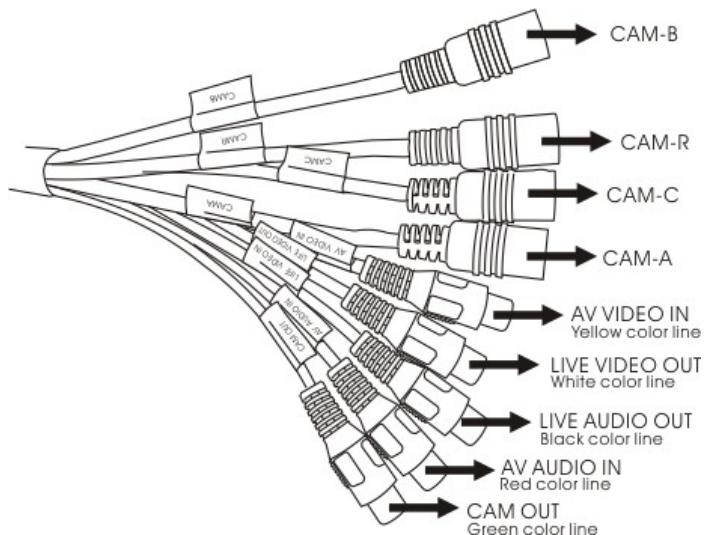

1. CAM R (Mini DIN) (NTSC/PAL system presume by this car rear CCD)
For 1st camera connection
2. CAM A (Mini DIN)
For 2nd camera connection
3. CAM B (Mini DIN)
For 3rd camera connection
4. CAM C (Mini DIN)
For 4th camera connection
5. LIVE VIDEO OUT (White Color RCA Jack)
On screen video loop out (for recording, second monitor or other device)
6. LIVE AUDIO OUT (Black Color RCA Jack)
On screen audio loop out (for recording, second monitor or other device)
7. AV VIDEO IN (Yellow Color RCA Jack)
Connection for any Video signal (DVD, VCD, Game)
8. AV AUDIO IN (Red Color RCA Jack)
Connection for any Audio signal (such as DVD, VCD, Game)
9. CAM OUT (Green Color RCA Jack)
Video loop out (for recording, second monitor or other device)

USER MANUAL

AWT07MLEDT

SIGNAL CABLE DESCRIPTION (CONTINUED)

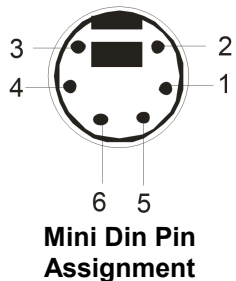

*** Type 1 (Standard):**

1. Video
2. -----
3. Audio
4. +12V
5. GND
6. -----

Function of the Audio	
Cam A	Audio from Cam A
Cam B	Audio from Cam B
Cam C	Audio from Cam C
Cam R	Audio from Cam R
Cam A + Cam B	Audio from Cam A
Cam C+ Cam R	Audio from Cam R
Cam A+ Cam R	Audio from Cam R
Cam R+ Cam B	Audio from Cam R
Cam A + Cam C	Audio from Cam A
Cam C+ Cam B	Audio from Cam C
Cam R / Cam AB	Audio from Cam R
Quad	Audio from Cam R
AV	Audio from AV

1. Cam Out: Composite video loop out signal to recorder, monitor or other device.
2. Live Video/Audio Out: On screen video/audio signal loop out to recorder, monitor or other device.

USER MANUAL

AWT07MLEDT

CONTROL CABLE DESCRIPTION

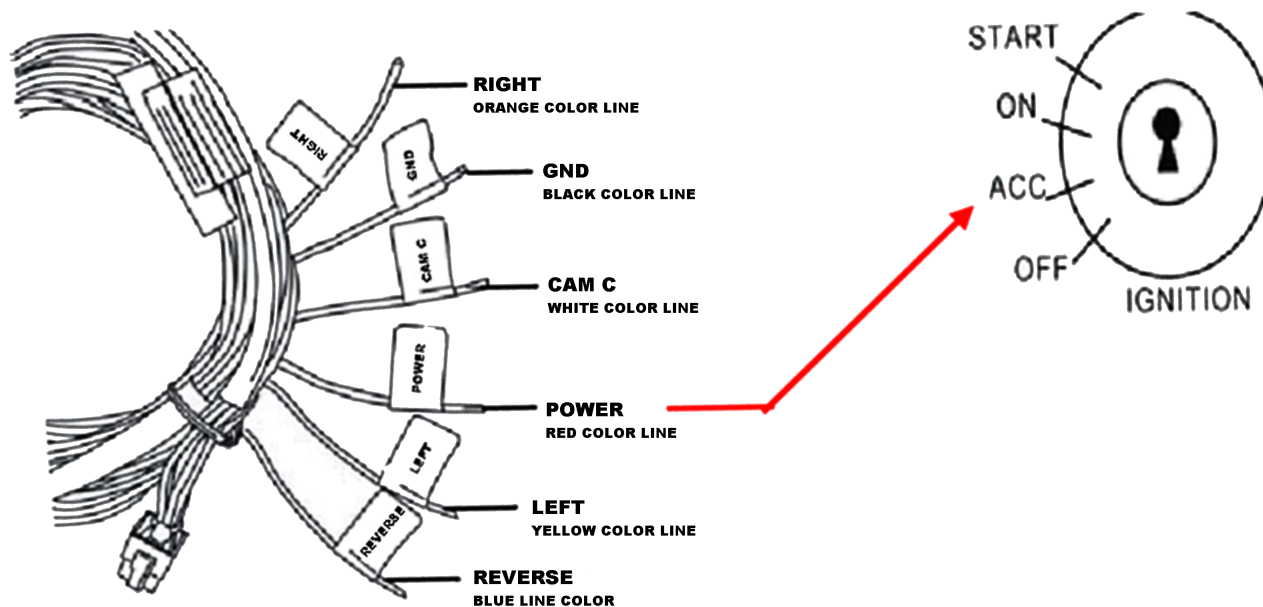

NOTICE

DO NOT connect the red wire (power wire) of this product directly to the battery. Connect the red wire of this product to the ACC of the ignition key switch. Failure to do so may result in permanent damage of the product.

USER MANUAL

AWT07MLEDT

CONTROL CABLE DESCRIPTION (CONTINUED)

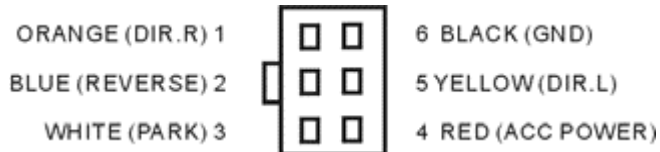

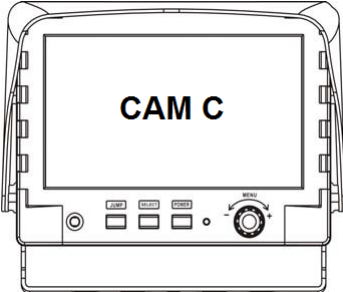
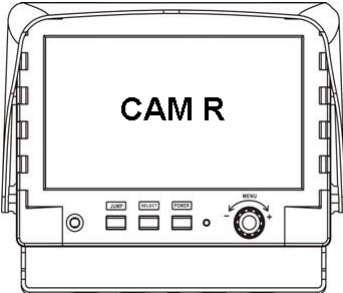
WIRE COLOR	FUNCTION	REMARK	ON SCREEN VIEW
RED	ACC POWER		
BLACK	GND		
WHITE	SW Control	Active Power Level Connect to CAM C	
BLUE	Reverse Control	Active Power Level Connect to Reverse Light	

USER MANUAL

AWT07MLEDT

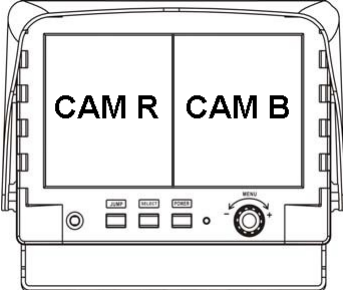
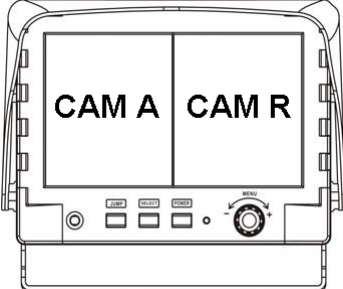
WIRE COLOR	FUNCTION	REMARK	ON SCREEN VIEW
ORANGE	Right Turn Control	Active Power Level Connect to Direction Light (R)	
YELLOW	Left Turn Control	Active Power Level Connect to Direction Light (L)	

1. The control cable sequence: Reverse > Right / Left / CAM C when Priority is ON. Right / Left / CAM C > Reverse when Priority is OFF.
2. With car power is on, the monitor power is off, when making a reverse / right / left turn, the monitor will display default screen.
3. You may push the “JUMP” button under event trigger when Priority is OFF.

USER MANUAL

AWT07MLEDT

FRONT PANEL CONTROL

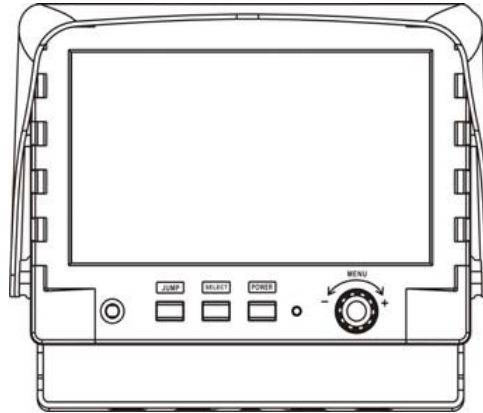

POWER	Press the power button to activate the monitor or to keep the monitor under stand by mode (In Red Led).
SELECT	With power on, press this button to select image sequence as below~ AV→CAM A+B→CAM C+R→CAM A+R→CAM R+B→CAM A+C→CAM C+B→CAM R/AB→CAM R+AB→CAM A→CAM B→CAM C→CAM R →AV..... Prerequisite : Display menu →Priority option is “ON”
JUMP	Press this button to display defined camera input, user can select QUAD→SEQ→CAM A+B→CAM C+R→CAM A+R→CAM R+B→CAM A+C→CAM C+B→CAM R/AB →CAM R+AB →CAM A →CAM B CAM C→CAM R via OSD as default value. Prerequisite : Display menu →Priority option is “ON”
MENU	This encoder switch provides the following function: Activate OSD menu: Press the Menu switch to activate the OSD menu. After the OSD menu is activated, in case users does not proceed for further set up, the OSD menu will then automatically turn off within 20 seconds. Enter Function: Press the encoder switch to act as “Enter” function under the OSD menu. Volume Value: Exit the OSD menu, user can turn this switch left or right to adjust the volume value.

USER MANUAL

AWT07MLEDT

FRONT PANEL CONTROL (CONTINUED)

OSD Menu

1. Press the MENU button to enter to the OSD Menu
2. Turn the MENU button left or right to select the setting you wish to proceed. The color of the content will turns YELLOW to identify your selection. Turn the MENU button left or right to adjust your setting value.
3. Press the MENU button once back to submenu and then press menu button again in order to return to OSD menu.

Enter to Main Menu:

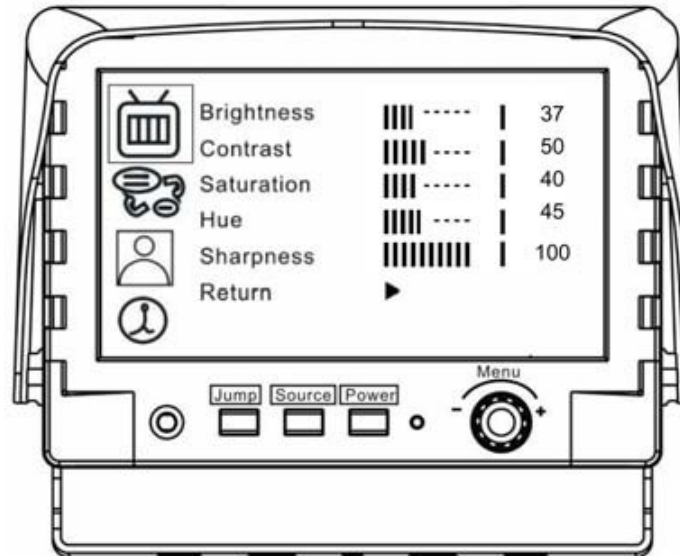

USER MANUAL

AWT07MLEDT

FRONT PANEL CONTROL (CONTINUED)



Screen Menu

This menu setup contains different setting for the TFT LCD.

	Brightness			37
	Contrast			50
	Saturation			40
	Hue			45
	Sharpness			100
	Return			

Brightness

Provide adjustment for shade and brightness level of TFT display. Setting value from 0 ~ 100. Default value is 37.

Contrast

Provide adjustment for the light and dark level of the TFT display. Setting value from 0 ~ 100. Default value is 50.

Saturation

Provide adjustment for the light intensity level of TFT display. Setting value from 0 ~ 100. Default value is 40.

Hue

Provide adjustment for the lightness and colorfulness level of TFT display. Setting value from 0 ~ 100. Default value is 45.

(Only in NTSC system is available.)

USER MANUAL

AWT07MLEDT

FRONT PANEL CONTROL (CONTINUED)



Screen Menu

This menu setup contains different setting for the TFT LCD.

	Brightness			37
	Contrast			50
	Saturation			40
	Hue			45
	Sharpness			100
	Return			

Sharpness

Provide adjustment for the edge contrast (acutance) level of TFT display. Setting value from 0 ~ 100. Default value is 100.

Return

Return to OSD menu selection screen.

USER MANUAL





AWT07MLEDT

FRONT PANEL CONTROL (CONTINUED)



DISPLAY Menu

This menu setup contains the on screen identification and the activation of the distance gauge.

	Auto Day& Night	OFF
	Display	ON
	Distance Gauge	ON
	OSD Lock	▶
	PRIORITY	OFF
	Reverse Mode	4:3
	Return	▶

Auto Day&Night

Select “ON” to activate the auto day & night function or “OFF” to deactivate it. Default value is OFF.

Display

Select “ON” to show the SELECT of video input title on screen or “OFF” to keep it invisible. Default value is ON.

Distance Gauge

Set the distance gauge “ON” to show the distance gauge on screen while reserving or “OFF” to deactivate. Default value is ON.

(This “DISTANCE GAUGE” is for user’s reference only)

OSD Lock

This function provides protection when an unauthorized person tries to access the OSD settings. JUMP and SELECT key press simultaneously for over 5 seconds to unlock. Default value is OFF.

NOTE: Users must turn on LCD in order to run unlock process. All function buttons are still working during OSD Menu lock up period.

USER MANUAL





AWT07MLEDT

FRONT PANEL CONTROL (CONTINUED)



DISPLAY Menu

This menu set up contains the on screen identification and the activation of the distance gauge.

	Auto Day& Night	OFF
	Display	ON
	Distance Gauge	ON
	OSD Lock	▶
	PRIORITY	OFF
	Reverse Mode	4:3
	Return	▶

PRIORITY

If Priority is ON

1. Press SOURCE button to select image sequence as below~ AV→CAM A+B→CAM C+R→CAM A+R→CAM R+B→CAM A+C→CAM C+B→CAM R/AB→CAM R+AB→CAM A→CAM B→CAM C→
2. CAM R →AV.....
3. Triggered mode priority: Reverse > Right/Left / CAM C
4. JUMP mode: QUAD
5. OSD Lock mode: OFF

If Priority is OFF

1. Press SOURCE button to select image sequence is as below~ AV→ CAM A→CAM B→CAM C→CAM R →AV.....
2. Triggered mode priority: Right/Left/CAM C > Reverse
3. JUMP mode: CAM R
4. OSD Lock mode: ON
Default value is "ON".

NOTE :When you choose "OFF" mode, OSD Lock function is enabled.

USER MANUAL

AWT07MLEDT

FRONT PANEL CONTROL (CONTINUED)



DISPLAY Menu





This menu set up contains the on screen identification and the activation of the distance gauge.

Reverse Mode

When reversing select LCD profile ratio 4:3 the display show in size 4:3 (default), select LCD profile ratio 16:9 to display in 16:9 size.

Return

Return to OSD menu selection screen.

	Auto Day& Night	OFF
	Display	ON
	Distance Gauge	ON
	OSD Lock	▶
	PRIORITY	OFF
	Reverse Mode	4:3
	Return	▶

USER MANUAL

AWT07MLEDT

FRONT PANEL CONTROL (CONTINUED)



CAMERA Menu

This menu setup contains the on Camera and Jump settings.



Mirror

The screen image setting of this panel during left / right turns.

Dir Image

Select "ON" to show the SELECT of video input title on screen or "OFF" to keep it invisible. Default value is ON.

Rear Setup

The screen image setting of this panel during reverse gear.

Jump

By pressing this button, the driver will be able to obtain the image selected under this setting.

Cam Out

Composite video loop out to recorder, monitor or other device.

SEQ Time Setup

Select Cam A/B/C/R switching time setting value from 02~100 Default value is "02"

Return Return to OSD menu selection screen.

USER MANUAL

AWT07MLEDT

FRONT PANEL CONTROL (CONTINUED)

Mirror

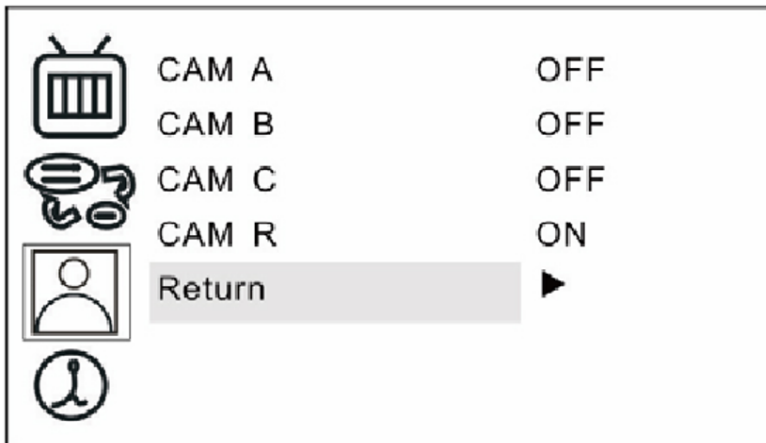

Select "ON" to activate the mirror function for different cameras or "OFF" for a normal image. Default values are following below setting.

CAM A "OFF"
CAM B "OFF"
CAM C "OFF"
CAM R "ON"

USER MANUAL

AWT07MLEDT

FRONT PANEL CONTROL (CONTINUED)

Dir Image

The screen image setting of this panel during left / right turn:

- TRIPLE: When you are making a right turn or left turn, the screen of panel will display triple images for left hand side, right hand side and rear view when you are making a right turn or left turn.
- DUAL: With proper wiring, the screen will display dual image for both rear and right hand side view when making a right turn. While left turning, the screen will show dual image for both rear and left hand side view.
- SINGLE: Screen of touch panel shows only single picture on direction turn. The screen will show only left side view on left turn and only right side view on right turn.

Default value is SINGLE.

USER MANUAL

AWT07MLEDT

FRONT PANEL CONTROL (CONTINUED)

Rear Setup

The screen image setting of this panel during reverse gear:

R:	Screen will display single image for Cam R only.
R+A:	Screen will display dual image for both Cam R and Cam A.
R+B:	Screen will display dual image for both Cam R and Cam B.
R/AB	Screen will display triple image from Cam R, Cam A, and Cam B.

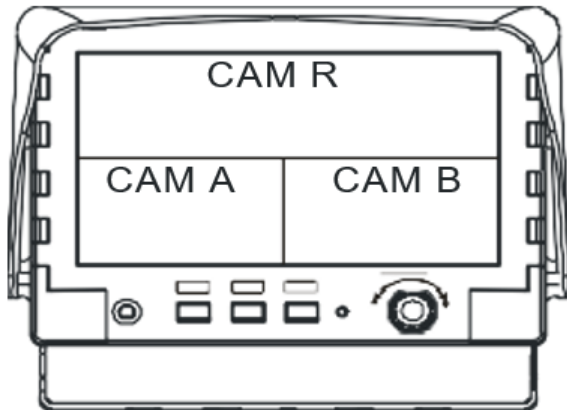

USER MANUAL

AWT07MLEDT

FRONT PANEL CONTROL (CONTINUED)

R+AB	Screen will display triple image from Cam R, Cam A, Cam B.
------	--

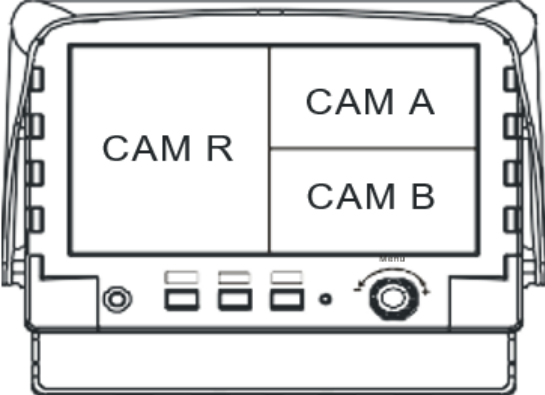

Default value is R.

USER MANUAL

AWT07MLEDT

FRONT PANEL CONTROL (CONTINUED)

Jump

By pressing this button, the driver will be able to obtain the image selected under this setting.

QUAD	Obtain image from all camera input in quad picture while pressing the JUMP button and press again to return the default screen.
SEQ.	Corresponding with “SEQ. Timer Step” setting to jump channel by time sequence.
CAM A	Obtain image from camera A while pressing the JUMP button and press again to return the default screen.
CAM B	Obtain image from camera B while pressing the JUMP button and press again to return the default screen.
CAM C	Obtain image from camera C while pressing the JUMP button and press again to return the default screen.
CAM R	Obtain image from camera R while pressing the JUMP button and press again to return the default screen.
CAM A+B	Obtain image from camera A+B in dual picture while pressing the JUMP button and press again to return the default screen.
CAM C+R	Obtain image from camera C+R in dual picture while pressing the JUMP button and press again to return the default screen.
CAM A+R	Obtain image from camera A+R in dual picture while pressing the JUMP button and press again to return the default screen.
CAM R+B	Obtain image from camera R+B in dual picture while pressing the JUMP button and press again to return the default screen.
CAM A+C	Obtain image from camera A+C in dual picture while pressing the JUMP button and press again to return the default screen.

USER MANUAL

AWT07MLEDT

FRONT PANEL CONTROL (CONTINUED)

CAM C+B	Obtain image from camera C+B in dual picture while pressing the JUMP button and press again to return the default screen.
CAM R/AB	Obtain image from camera R+A+B in triple picture while pressing the JUMP button and press again to return the default screen.
CAM R+AB	Obtain image from camera R+A+B in triple picture while pressing the JUMP button and press again to return the default screen.

Default value is QUAD.

Cam Out

Composite video loop out to recorder, monitor or other device.

QUAD	Recording or viewing from the output device in quad mode
CAM A	Recording or viewing from the output device for CAM A image
CAM B	Recording or viewing from the output device for CAM B image
CAM C	Recording or viewing from the output device for CAM C image
CAM R	Recording or viewing from the output device for CAM R image

Default value is QUAD.

SEQ Time Step

Select Cam A/B/C/R switching time setting value from 02~100 Default value is "02"

Return

Return to OSD menu selection screen.

USER MANUAL

AWT07MLEDT

FRONT PANEL CONTROL (CONTINUED)



Information

This menu setup contains Recall & Exit functions.

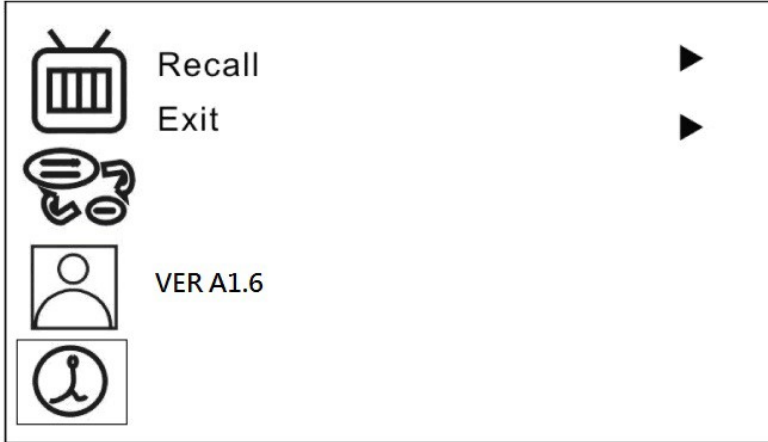

Recall

Recall factory default.

Exit

Exit OSD menu.

Note: Firmware version will be displayed on last column.

USER MANUAL

AWT07MLEDT

VEHICLE INSTALLATION

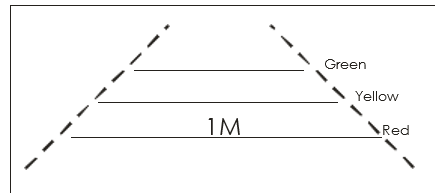
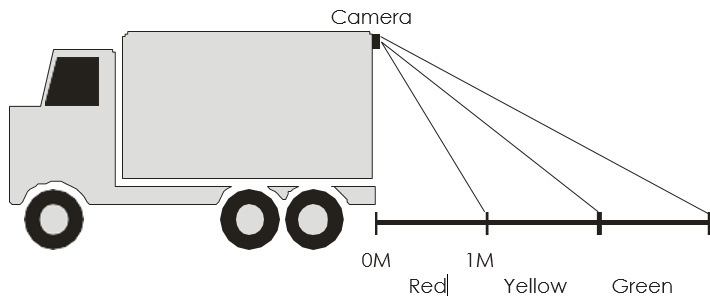

NOTE: This “DISTANCE GAUGE” is for user’s reference only.

1. Install Camera R (for rear view)
2. Use a measuring tool to mark out the distance behind the vehicle.
3. Adjust the viewing angle of the camera so that the distance gauge shown from the TFT match to the distance marks behind the vehicle.
4. Switch to Rear view with SELECT button, the screen always display on 16:9 While rear viewing, the screen always display on 4:3 to correct size percentage

USER MANUAL

AWT07MLEDT

VEHICLE INSTALLATION (CONTINUED)

SELECT button:



Rear viewing:

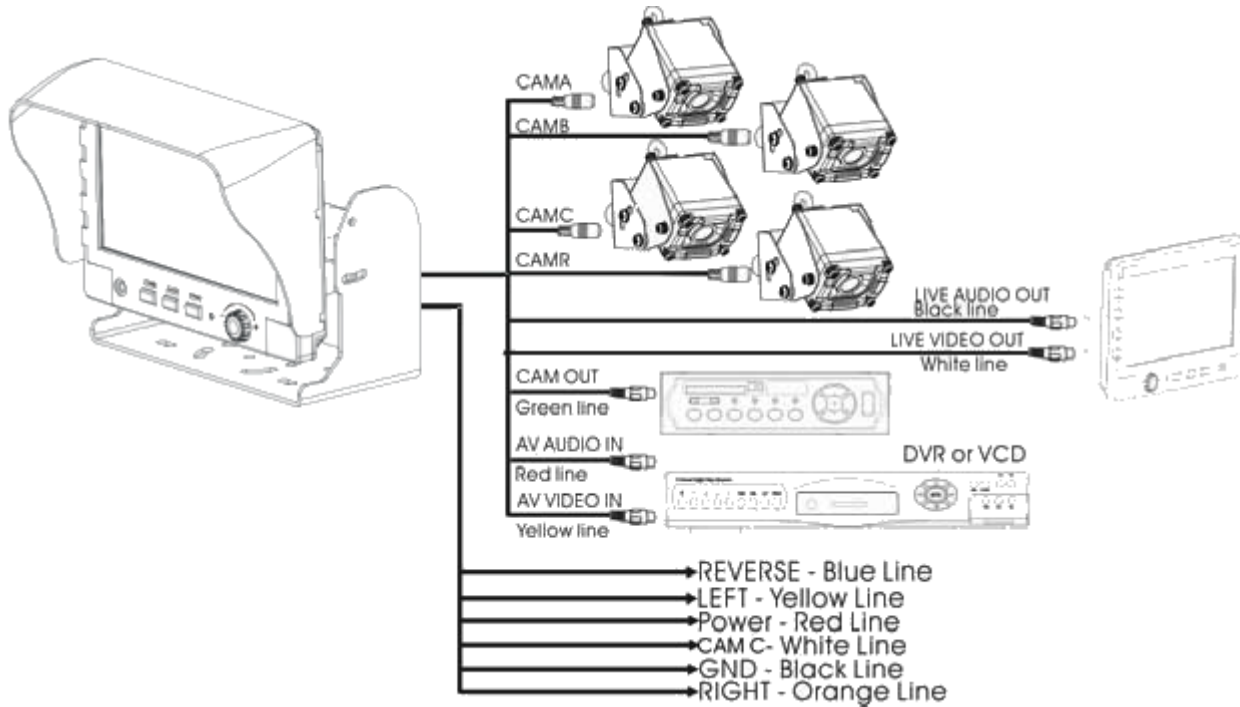
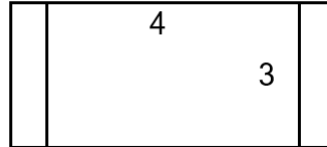

USER MANUAL

AWT07MLEDT

SPECIFICATIONS

Screen size	7 Inch Touch Panel (diagonal)
Active area	154.08(H) x 86.58(V)
Pixel configuration	0.107 x 0.370
Resolution	1440(W) x 234 (H)
Viewing angle	UP:40° / Down:60° / Left: 60° / Right:60°
Power source:	DC9.6V ~DC32V
Contrast ratio	300:1*
Brightness	450 cd/m2 *
<u>AV Video In</u>	
Connector	RCA
Input Signal	1Vpp
Impedance	75 Ohms
<u>AV Audio In</u>	
Connector	RCA
Input video signal level	1Vpp
Impedance	1K Ohms

USER MANUAL

AWT07MLEDT

SPECIFICATIONS (CONTINUED)

<u>Camera MINI DIN In</u>	
Connector	6 PIN MINI DIN (Standard)
Input video signal level	1Vpp
Impedance	75 Ohms
Input audio signal level	1Vpp
Power output for camera	DC12V 350mA
<u>Dimensions</u>	
W x H x D :	192 x140.5 x 51.8mm
Weight	N.W. / G.W.: 2kg / 2.28kg
<u>Environmental</u>	
Operation temperature	-10°C~70°C
Storage temperature	-30°C~80°C
Humidity	20%-80%

*The brightness and contrast ratio specifications are from panel specification.

Design and Specifications are subject to change without notice.

A1.6

USER MANUAL

AWT07MLEDT

MOUNTING

Attachment 1: Dimension Chart

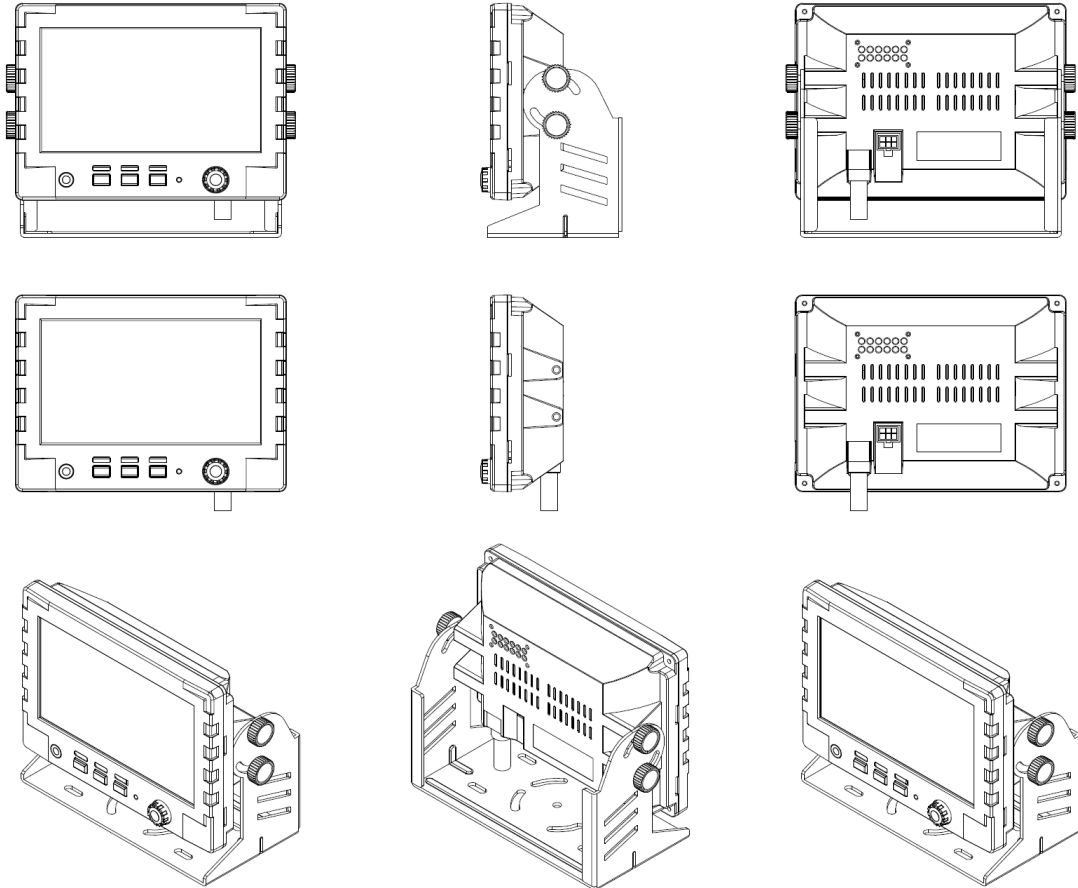

USER MANUAL

AWT07MLEDT

MOUNTING (CONTINUED)

Attachment 2: Installation Chart

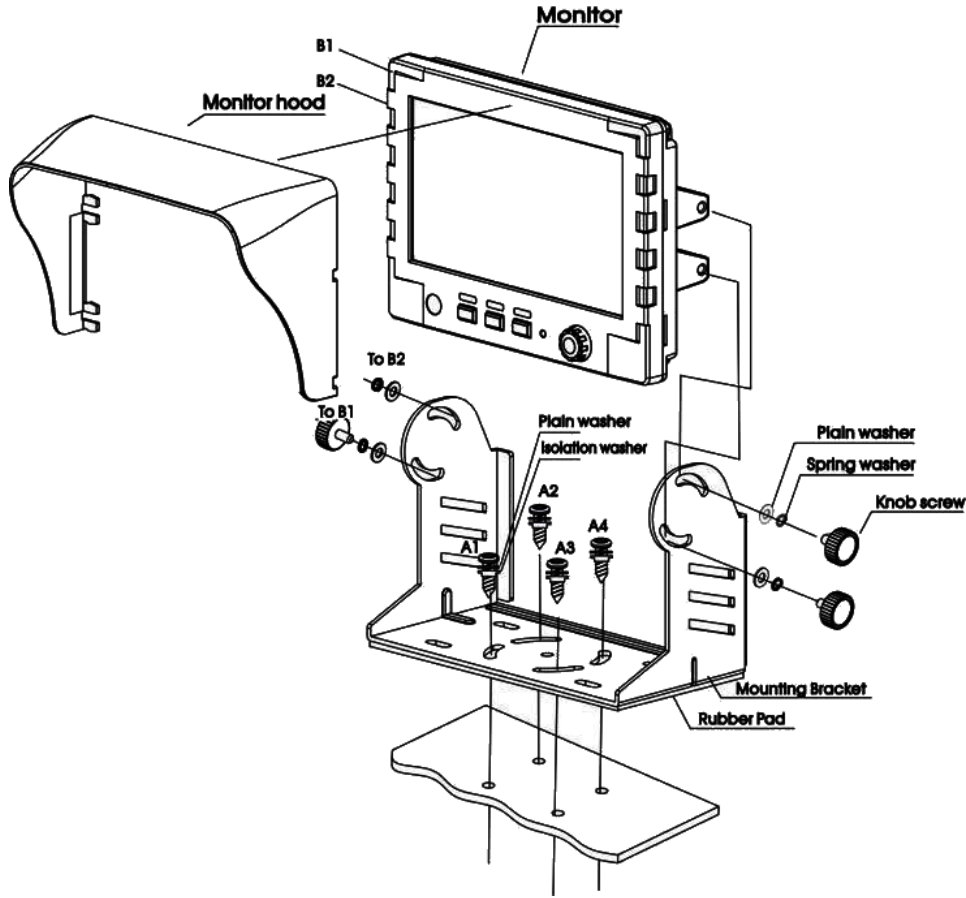

USER MANUAL

AWT07MLEDT

CABLE CONNECTIONS

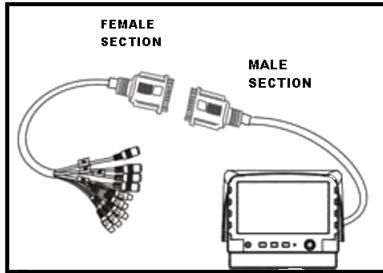

1. The first part of the cable which connected with the LCD Monitor, herewith we called the Male Section
2. The second part of the cable which ended with the RCA/MINI DIN connectors, herewith we called the Female Section.

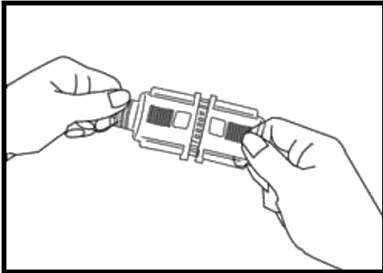

Connection steps are:

1. Connect the "Male Section" to the "Female Section".

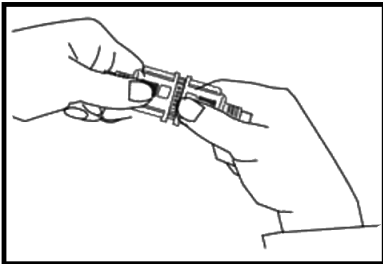

2. Tighten up the side screws.

NOTE: The Cable should be stored in a dry place and please try to avoid the water and humidity, otherwise, it may cause problem of the product itself or even more dangerous.

C

- cable connections 33
- control cable description
 - wire colors 9
 - wire functions 9

F

- features 4
- front panel control
 - buttons 12
 - camera 19
 - display 16
 - information 26
 - OSD menu 13
 - switches 12

M

- mounting 31

P

- package contents 5

S

- screen menu 14
- signal cable description
 - audio functions 7
- specifications 29

T

- TFT installation 6

V

- vehicle installation
 - wiring diagram 27

3RD EYE WARRANTY

3RD EYE PRODUCTS LIMITED WARRANTY

3rd Eye warrants that the 3rd Eye Hardware and Software, as delivered by 3rd Eye to Client, will be free from defects in materials and workmanship in accordance to the terms and conditions specified herein. This warranty is a "parts replacement only" policy, and does not cover labor. Other limitations apply as provided below.

TERMS & CONDITIONS

DEFINITIONS

- 1.1 "Hardware" means cameras, monitors, Gateway and related peripheral hardware.
- 1.2 "Software" shall mean the Application or Embedded Software.
- 1.3 "Self-Service Client" shall mean any client that maintains their own equipment and is not under Service Agreement with 3rd Eye.

WARRANTY PERIOD

- 2.1 Unless a separate written Agreement with 3rd Eye is provided, a 1 Year warranty from the original date of hardware installation or the original date of purchase, whichever occurs first shall apply. Troubleshooting, labor, travel time, freight and miscellaneous costs are not covered.
- 2.2 New replacement hardware covered under warranty shall be covered under warranty for the remaining period of the initial warranty term.
- 2.4 Refurbished hardware and hardware installed by the customer shall carry a 90-day replacement warranty from the original date of hardware installation or the original date of purchase, whichever occurs first shall apply.
- 2.5 Labor and workmanship provided by a certified 3rd Eye technician shall carry a 90-day replacement warranty from the original date of service.

WARRANTY REIMBURSEMENT

- 3.1 To submit for warranty reimbursement, Client must notify 3rd Eye in writing by obtaining a 3rd Eye Return Material Authorization (RMA) number within the relevant Warranty Period. The authorized RMA the Client receives must be marked on the outside of the package returning the failed component and sent prepaid and packaged appropriately for safe shipment. The RMA number will serve as the warranty claim reference number. 3rd Eye will either repair or replace the defective component at its discretion. To request for an RMA number please complete the online RMA form found at www.3rdEyecam.com or call 866.804.2984.
- 3.2 If the failure analysis of the returned hardware determines the cause of failure was other than material or workmanship covered under the terms of this limited warranty, the CUSTOMER agrees to pay 3rd Eye Cam for the replacement hardware, labor and expenses.

WARRANTY DISCLAIMER

- 4.1 This warranty shall become null, void, and not apply if Client fails to notify 3rd Eye in writing of such defects prior to the expiration of the Warranty Period, if the defect is not reproducible, or if the defect is caused by (a) customer damage, negligence, misuse, tampering, accident, fire, variation or interruption of electricity; (b) failure by Client to properly install, maintain, or use the 3rd Eye Hardware or the Third Party Hardware; (c) alterations made by anyone other than 3rd Eye to the 3rd Eye Hardware or the hardware and/or software that interfaces with the 3rd Eye Hardware after installation; (d) any attempt to service the 3rd Eye Hardware other than by 3rd Eye's service technicians or (e) any hardware, software or part not approved by or not supplied by 3rd Eye. 3rd Eye shall not be responsible for the safeguarding or retention of Client's or any third-party software, firmware, information or memory data contained in, stored on, or integrated with any 3rd Eye Hardware that is returned to 3rd Eye pursuant to any warranty provided under this Agreement.
- 4.2 3rd Eye hereby disclaims all warranties, express, implied, or statutory, including, without limitation, the warranties of merchantability, fitness for a particular purpose. 3rd Eye makes no claim that the software will work in combination with any hardware or software products provided by third parties, that the operation of the software will be uninterrupted or error-free, that all defects in the software can be corrected, or that any specific result or outcome will be achieved by utilizing the products or third-party hardware provided by 3rd Eye.



3RD EYE®

www.3rdeyecam.com

UG(H Customer Care:
866-804-2984

(QYLURQPHQWDO6ROXWLRQV*URXS
:0DLQ6WUHHW6WH
&KDWWDQRRJD71